

CERAMIC HEATER

Model:
HCH-LH2000BK



This product is only suitable for well insulated spaces or occasional use

- Humidifier function
- Remote control
- ECO function

HEINNER

1. INTRODUCTION

Please read this instruction manual carefully before using it and keep it for later information.

This manual is conceived for offering you all of the necessary info regarding installation, using and maintenance of the machine. For a correctly and safely use of the machine, please, read this manual before installation and using.

2. PACKAGE CONTENTS

- Ceramic fan heater
- Instruction manual
- Warranty card

3. SAFETY WARNINGS AND PRECAUTIONS

1. Please read all instructions carefully before using this product.
2. This product is for household use only.
3. This appliance is not intended for use by persons (including children) with reduced physical, sensory or mental capabilities, or lack of experience and knowledge, unless they have been given supervision or instruction concerning use of the appliance by a person responsible for their safety.
4. Children should be supervised to ensure that they do not play with the appliance.
5. This appliance can be used by children aged from 8 years and above and persons with reduced physical, sensory or mental capabilities or lack of experience and knowledge if they have been given supervision or instruction concerning use of the appliance in a safe way and understand the hazards involved. Children shall not play with the appliance. Cleaning and user maintenance shall not be made by children without supervision.
6. If the supply cord is damaged, it must be replaced by the manufacturer, its service agent or similarly qualified persons in order to avoid a hazard.
7. Children of less than 3 years should be kept away unless continuously supervised.
8. Children aged from 3 years and less than 8 years shall only switch on/off the appliance provided that it has been placed or installed in its intended normal operating position and they have been given supervision or instruction concerning use of the appliance in a safe way and understand the hazards involved. Children aged from 3 years and less than 8 years shall not plug in and clean the appliance or perform user maintenance.
9. **CAUTION**- Some parts of this product can become very hot and cause burns. Particular attention has to be given where children and vulnerable people are present.
10.  **WARNING:** In order to avoid overheating, do not cover the heater.
11. Do not use this heater in the immediate surroundings of a bath, a shower or a swimming pool.
12. The heater must not be located immediately below a socket outlet.
13. **WARNING:** Do not use this heater in small rooms when they are occupied by persons not capable of leaving the room on their own, unless constant supervision is provided.
14. Do not use this heater if it has been dropped
15. Do not use if there are visible signs of damage to the heater
16. Use this heater on a horizontal and stable surface.
17. **WARNING:** To reduce the risk of fire, keep textiles, curtains, or any other flammable material a minimum distance of 1 m from the air outlet
18. If the supply cord is damaged, it must be replaced by the manufacturer, an authorized service or similarly qualified persons in order to avoid a hazard.

19. If the product has any failure, please take it to a service station or notify the after-sales service center.
20. Do not disassemble or replace parts without authorization.
21. Do not touch the power cord and plug with wet hands.
22. It is strictly forbidden to insert foreign objects such as wooden and metal sticks into the air inlet and outlet.
23. Do not spray insecticides or flammable sprays around the product.
24. Avoid blowing air to young children for a long time.
25. Do not pull the cord abruptly when unplugging the power cord.
26. Make sure that there is no foreign matter stuck on the power plug, and fully insert the plug.
27. If the product has any strange smell or noise during use, stop using it immediately and unplug the power supply.
28. Do not fold the power cord or place heavy objects on it.
29. When going out or not using the device for a long time, be sure to turn off the power and unplug the power cord.
30. Only use conforming power outlet that meets the requirements.
31. Make sure that the power voltage used is consistent with the voltage specified on the nameplate of the device.
32. Please confirm the operating voltage before relocating.
33. Do not place any object on the device.
34. Be aware that high humidity levels may encourage the growth of biological organisms in the environment.
35. Do not permit the area around the humidifier to become damp or wet. If dampness occurs, turn the output of the humidifier down. If the humidifier output volume cannot be turned down, use the humidifier intermittently. Do not allow absorbent materials, such as carpeting or curtains to become damp.
36. Unplug the appliance during filling and cleaning.
37. Never leave water in the reservoir when the appliance is not in use.
38. Empty and clean the humidifier before storage. Clean the humidifier before next use.
39. **Warning:** Micro-organisms that may be present in the water or in the environment where the appliance is used or stored, can grow in the water reservoir and be blown in the air causing very serious health risks when the water is not renewed and the tank is not cleaned properly every 3 days.
40. Empty the tank and refill every third day. Before refilling, clean it with fresh tap water or cleaning agents if required by the manufacturer. Remove any scale, deposits, or film that has formed on the sides of the tank or on interior surfaces and wipe all surfaces dry.
41.  Clean the water tank every three days.
42. After the water tank is filled with water, do not tilt or bump it when placing or moving in order to prevent water splashing. If the product has been tipped over and there is water in the machine, unplug it immediately and wait for 24 hours for drying before turning it on.
43. The water level of the water tank must not exceed the maximum scale.
44. This product contains a coin/button cell battery. If the coin/button cell battery is swallowed, it can cause severe internal burns in just 2 hours and can lead to death.
45. Keep new and used batteries away from children.
46. If the battery compartment does not close securely, stop using the product and keep it away from children.
47. If you think batteries might have been swallowed or placed inside any part of the body, seek immediate medical attention.
48. The batteries contain materials which are hazardous to the environment; they must be removed from the appliance before it is scrapped and that they are disposed of safely.

4. PRODUCT DESCRIPTION

Product overview

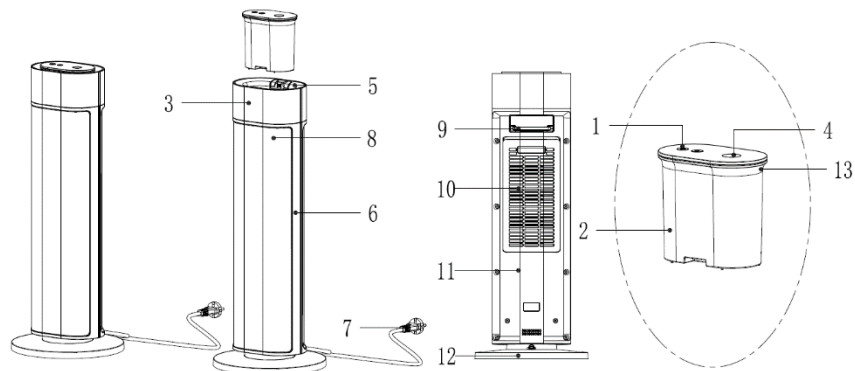

1. Button	8. Outlet mesh
2. Water tank	9. Remote control tray
3. Control panel	10. Rear grid
4. Spray plate	11. Rear shell
5. Top cover	12. Base
6. Front shell	13. Exhaust vent
7. Power cord	

Operation panel

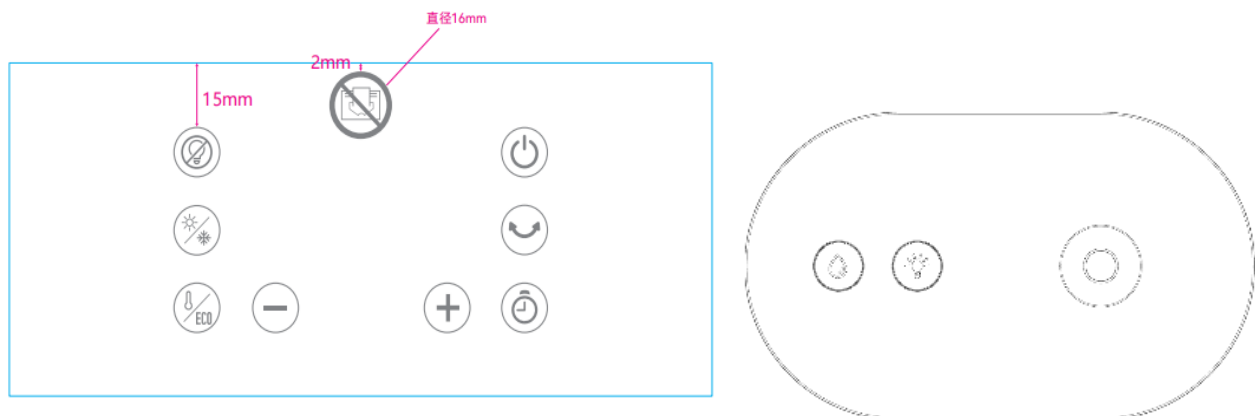

Display panel



Remote control operation panel

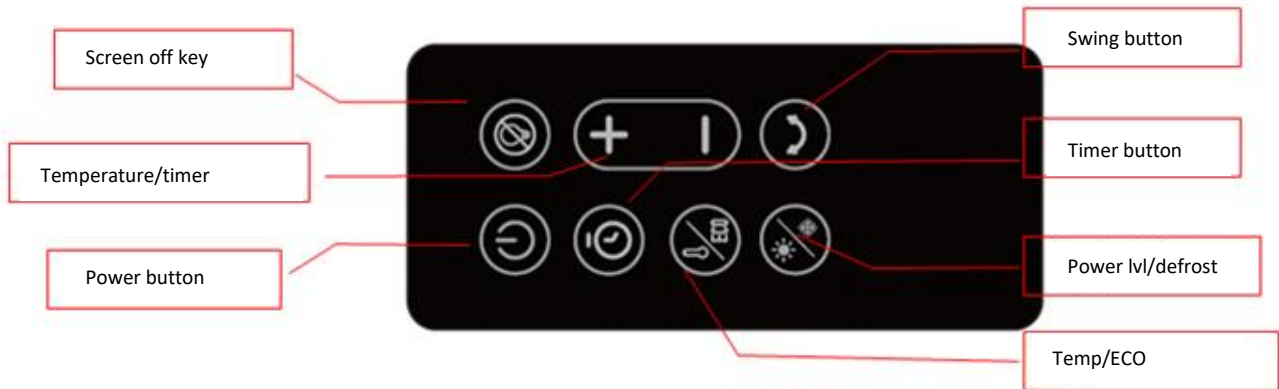

5. PRODUCT INSTALLATION AND OPERATION METHOD

Installation method

1. Take the product out of the package, including 3 components: main unit, remote control, and base;
2. Put the base on a clean table surface, align the body with the base and assemble as shown in the figure below:

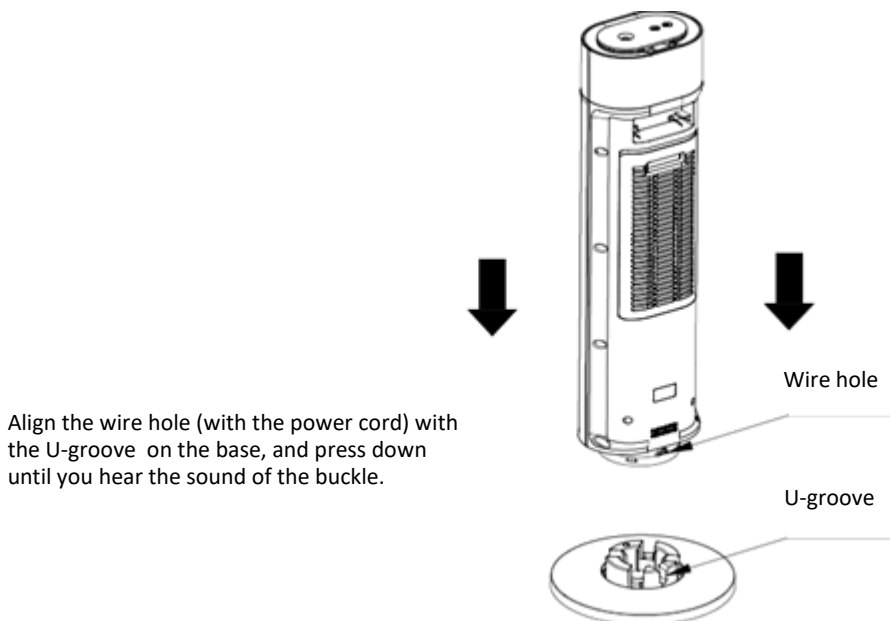



Align the wire hole (with the power cord) with the U-groove on the base, and press down until you hear the sound of the buckle.





3. Connect the power supply, press the power button to use or take out the remote control to use directly.

How to use each function button

1. Power button



When the power is turned on, the machine makes a sound and enters the standby state, the nixie tube displays "--", and all other function indicators are off, except the  button and the  timer button.

In standby mode, press the  button to turn on and press it again to turn off; the default state after turning on is:





- a) During low-level power heating, low-level Led_  is on, high-level Led_  is off, and defrosting LED_  is off.
- b) In continuous heating state, the nixie tube shows that the default set temperature is 35°C, and LED_  is on.
- c) No timer, led_ **h** is off.
- d) The fan is on.
- e) ECO is off, led_  is off.

Note: The temperature judging function will not be executed within 10 seconds after starting up, and the fan will be turned off after a delay of 30 seconds after the heating state is turned off. As long as the PTC is in the working state, the fan must be in the working state. Whenever the PTC stops working, the fan continues to work for 30 seconds and then stops.

II. Swing button:

In the power-on state, press the  button to switch the swing function on and off, and the indicator light Led_  will be on and off correspondingly.

III. Timer button

1. In the power-on state, press the  button to enter the schedule power-off function setting. The settable range is 0-24H (0 means no timer), and the schedule time is not accumulated; in the setting state, if there is no operation within 5 seconds or press any button other than ,  and , the setting completes and the countdown starts. After the countdown ends, the machine turns off and enters the standby state without making a sound.



2. In the standby state, press the  button to enter the schedule function setting, led “h” lights up, and the setting range is 1-24H (0 means no timer). The schedule time does not accumulate; in the setting state, if there is no operation within 5 seconds, the setting completes, the countdown starts, and the nixie tube will flash to display the schedule time. After the countdown is over, the machine will automatically turn on and remember the function before the last shutdown (schedule power-off function isn't memorized).

IV. Screen off button:

In the power-on state, press the screen off button to turn on the off-screen function, the machine enters the off-screen function, and all the indicators go out; when the machine is in the off-screen state, press the screen off  button or any button for the first time, the indicator lights return to normally on, and the function does not switch; press other buttons to execute the corresponding button function.

V. Power level/defrost button:



In the power-on state, press the  power level/defrost function switch button to switch in the following sequence: low level heating → high level heating → defrosting mode → low level heating...:

- 1. Low-level heating: PTC works at low level and led_  lights up.
- 2. High-level heating: PTC works at high level and led_  lights up. (When switching from low level to high level, the PTC high level will work after a 10-second delay. The low-level power indicator light will not be on.)

3. Defrost mode: After entering the defrosting intelligent mode, led_❄️ lights up, and the machine operates automatically to keep the room temperature at 7°C.

VI. Temperature/ECO button:

In the power-on state, press the  temperature/ECO function button to switch in the following sequence: temperature setting → ECO mode → temperature setting...:

1. The temperature setting range is 15°C-35°C;
2. In the setting state, if there is no operation within 5 seconds or any button except ,  and  is pressed, the setting completes;
3. When the ambient temperature reaches the set temperature, all functions are turned off (entering the shutdown and dormant state), and when the ambient temperature drops to 2°C lower than the set temperature, the turned off functions are turned on again;
4. The nixie tube only displays the temperature by default. Only when the timer is set, the temperature and timer will be displayed alternately, with an interval of 30 seconds;
5. ECO mode: After entering the ECO intelligent operation mode, led_ECO lights up, and the nixie tube does not display (when the timer is not turned on). The machine automatically adjusts the heating power according to the room temperature, making the device more energy-saving and environmentally friendly. Its operation rules are as follows;
 - When the ambient temperature is equal to or lower than 18°C, the PTC operates at a high power;
 - When the ambient temperature is greater than 18°C and lower than 25°C, the PTC operates at low power;
 - When the ambient temperature is equal to or greater than 25°C, all functions are turned off. The machine will stand by.

VII. “-” button:

In the temperature and timer setting state, press the  button to adjust the set value downward; press and hold for more than 2 seconds to realize the quick setting function.

VIII. “+” button:

In the temperature and timer setting state, press the  button to adjust the set value upward; press and hold for more than 2 seconds to realize the quick setting function.

IX. Ambient light button :

Press the ambient light button to switch the ambient light on and off.

X. Humidifier button :

1. Description of 3-day cleaning reminder function:

Every time the power is turned on, the ambient light will flash, and while there is a long "Bi- -" sound, indicating that the machine needs to be cleaned. The humidifier function can be turned on normally when you press the humidifier button to cancel the reminder function.

When the power is on all the time, the humidifier module automatically counts and reminds at intervals of 3 days. When the reminder is issued, the humidifier module is in standby mode and sends out a cleaning reminder. The ambient light flashes to remind the machine that it needs to be cleaned. The humidifier function can be turned on normally when you press the humidifier button to cancel the reminder function.

When the 3-day cleaning reminder takes effect (the cleaning reminder is sent out, the ambient light flashes, indicating that the machine needs to be cleaned), but the heating module on the machine is not affected, and the heating function can be turned on/off normally.

There is a short sound when you cancel the 3-day cleaning function or turn on humidification, and there is a long sound when you turn off humidification.

2. Water shortage protection:

When the humidifier is turned on, it first detects the water level for 1 second (the spraying function is not turned on at this moment). If water is detected, the spraying function is turned on; if water shortage is detected for 6 seconds consecutively, it enters the water shortage protection state, and the ambient light flashes 1 minute (without turning on the spraying function); you can press the humidifier button to exit the humidification, and the ambient light will resume normal operation.

3. Precautions for use:

- The absorbent cotton stick of this product is dry when it is used for the first time. It can be completely immersed in water and fully absorbed before installation and use, which can reduce the waiting time for water absorption;
- If the mist vent is blocked by foreign bodies or water droplets, it will affect the mist. Please clean up the foreign bodies or water droplets before normal use;

XI. Other functions:

- Automatic standby function: It will automatically shut down after 12 hours of continuous running (no operation during the period) and enter the standby state.
- Overturning protection function: after the machine is overturned, it will enter the power-off protection state. After recovery, it can enter the standby state.
- After the machine works continuously for 1 minute without operation, the LED display becomes dark, which solves the problem of dazzling LED lights at night. The brightness restores when there is any operation.
- Constant power memory function: when the power is not cut off, it will keep the working state before the shutdown, except for the timer function.
- Keep the water tank and water clean and use pure water or distilled water for testing. If the water is not clean, the micropores of the atomizer will be blocked by foreign matter, which will affect the mist output and life.

Use of the remote control

- Open the battery door at the bottom of the remote control, as shown in Fig. 3 (press the button on the battery door inward and pull the battery door out).
- Check the polarity of the battery, and put the battery into the slot of the battery door, as shown in Fig. 4.
- Insert the battery door back into the bottom of the remote control.

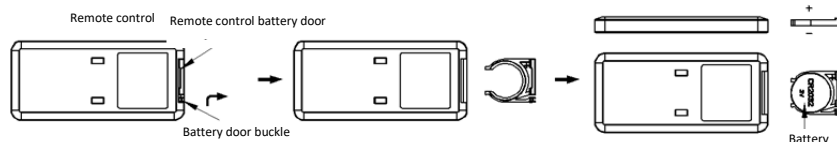

(Fig. 3)

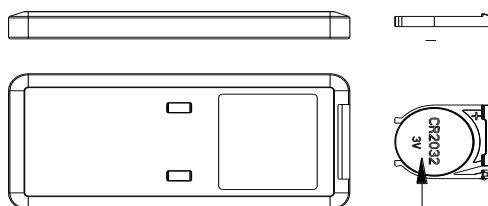

(Fig. 4)

6. REPAIR AND MAINTENANCE

1. Before cleaning, repairing and maintaining, please turn off the power and pull out the plug
2. To clean the surface, wipe with a dry cloth. Do not use gasoline, thinner or corrosive detergent or solvent.
3. Do not rinse with water.
4. If too many foreign matters adhere to the filters, it will affect the air blowing effect, so please clean them at least once every month.
5. Do not use chemicals for cleaning.
6. Take out the filters in order (as shown below)
7. Filter cleaning: soak the filters with detergent for a few minutes, and then clean and dry them.
8. Install the filters in order. Ensure that the installation is correct.
9. Please pack the device when it is not in use for a long time.

7. TECHNICAL PARAMETERS

Model	HCH-LH2000BK
Rated voltage	220-240V~
Rated frequency	50 /60Hz
Rated power	2000 W
Noise	≤45 dB

Model identifier(s): HCH-LH2000BK					
Item	Symbol	Value	Unit	Item	Unit
Heat output				Type of heat input, for electric storage local space heaters only (select one)	
Nominal heat output	P _{nom}	2.0	kW	manual heat charge control, with integrated thermostat	NA
Minimum heat output (indicative)	P _{min}	1.3	kW	manual heat charge control with room and/or outdoor temperature feedback	NA
Maximum continuous heat output	P _{max,c}	2.0	kW	electronic heat charge control with room and/or outdoor temperature feedback	NA
Auxiliary electricity consumption				fan assisted heat output	NA
At nominal heat output	e _{lmax}	0,000	kW	Type of heat output/room temperature control (select one)	
At minimum heat output	e _{lmin}	0,000	kW	single stage heat output and no room temperature control	No
In standby mode	e _{lSB}	0.0005	kW	Two or more manual stages, no room temperature control	No
				with mechanic thermostat room temperature control	No
				with electronic room temperature control	Yes
				electronic room temperature control plus day timer	No
				electronic room temperature control plus week timer	No
				Other control options (multiple selections possible)	
				room temperature control, with presence detection	No
				room temperature control, with open window detection	No

				with distance control option	No
				with adaptive start control	No
				with working time limitation	Yes
				with black bulb sensor	No
Contact details:				Network One Distribution Marcel Iancu Street, no. 3-5, Bucharest, Romania Tel: +40 21 211 18 56, www.heinner.com , www.nod.ro	

CUSTOMER CARE AND SERVICE

Always use original spare parts.

When contacting our Authorised Service Centre, ensure that you have the following data available: Model and Serial Number.

The information can be found on the rating plate. Subject to change without notice.

Thank you for purchasing this product. If you need support with your product, visit our website using the links below.

Get User manuals: <https://www.heinner.ro>

Get Service information: <https://www.heinner.ro>



Environment friendly disposal

You can help protect the environment!

Please remember to respect the local regulations: hand in the non-working electrical equipment's to an appropriate waste disposal center.



HEINNER is a registered trademark of **Network One Distribution SRL**. Other brands and product names are trademarks or registered trademarks of their respective holders.

No part of the specifications may be reproduced in any form or by any means or used to make any derivative such as translation, transformation, or adaptation without permission from NETWORK ONE DISTRIBUTION.

Copyright © 2013 Network One Distribution. All rights reserved.

www.heinner.com, <http://www.nod.ro>



This product is in conformity with norms and standards of European Community.



Importer: **Network One Distribution**

Marcel Iancu Street, 3-5, Bucharest, Romania

Tel: +40 21 211 18 56, www.heinner.com , www.nod.ro