



Enjoy it.

BAC-PO-1414-Q11L

CONTENT

IMPORTANT SAFEGUARDS	5
GETTING STARTED	8
CONTROL PANEL & OUTLINE OF FUNCTIONS.....	16
REMOTE CONTROL FUNCTION.....	24
IMPORTANT MESSAGES.....	25
TROUBLESHOOTING.....	36
SPECIFICATION.....	37
MODEL CODE BREAKDOWN	38

PORTABLE AIR CONDITIONER

A1414L

BAC-PO-1414-Q11L

User Manual

IMPORTANT SAFEGUARDS

Read the user manual carefully before installation and use of this portable air conditioner.

Please retain this user manual for product warranty and future reference.

CAUTION

1. Do not attempt to accelerate the defrosting process or clean this appliance in ways other than those recommended by the manufacturer.
2. This appliance should be stored in a room without continuously operating ignition sources (such as open flames, running gas appliances, or running electric heaters.)
3. Do not pierce or burn this appliance.
4. Be aware that refrigerants may not emit any odours.
5. This appliance should be installed, operated, and stored in a room with a floor area larger than 13m².
6. Servicing should be performed only as recommended by the manufacturer.
7. This appliance should be stored in a well-ventilated area where the room size corresponds to the area as specified for operation.
8. All procedures that affect safety should only be carried by competent personnel.



Caution, risk of fire!



9. "PLEASE MAKE SURE THE PRODUCT VENTILATES AT ALL TIMES"! Make sure the inlet and outlet ventilation is not blocked at all times.
10. Use this appliance on a horizontal surface to avoid water leakage.
11. Do not use this appliance in an explosive or corrosive atmosphere.
12. Use this appliance in a room with an ambient temperature of 35°C or less.
13. The heating function of this appliance should only be used in a room with an ambient temperature between 7°C and 23°C.
14. Clean the air filter periodically to ensure efficient cooling.
15. When the appliance is shut off, wait for at least 3.5 minutes before starting it again to prevent the compressor from being damaged.
16. This appliance requires at least 7 Amps of electricity to operate its compressor. To avoid household electricity outages, do not use any extension cords for this appliance.
17. When turning on the appliance, the fan will begin immediately. The compressor will start up after the cooling alarm flashes for three minutes.
If set to heating mode, the heating alarm will flash for 3.5 minutes before the compressor and fan start up.
18. If the supply cord is damaged, it must be replaced by the manufacturer, its service agent, or similarly qualified personnel to avoid hazard.
19. Remove all batteries from this appliance before disposal to ensure safety.
20. This appliance should only be used by children aged 8 years and above or persons with reduced physical, sensory, or mental capabilities, or lack of experience and knowledge if they are supervised and have been given instruction concerning its safe use and the hazards involved. Do not allow children to play with the appliance. Cleaning and user maintenance should not be carried out by children without supervision.

21. This appliance can only be connected to a supply with a system impedance no more than 0.219Ω . In case necessary, please consult your utilities provider for system impedance information.
22. This appliance must be installed in accordance with national wiring regulations.
23. Do not use this appliance in humid environments such as bathrooms or laundry rooms. (Not suitable for window kit models)

Appliance Transportation, Marking, and Storage

1. Transport of equipment containing flammable refrigerants must be compliant with transport regulations.
2. Equipment marking must be compliant with local regulations.
3. Disposal of equipment using flammable refrigerants must be compliant with national regulations.
4. Storage of equipment/appliances must be in accordance with manufacturer instructions.
5. Storage of packed (unsold) equipment should be done so in a way that mechanical damage to the equipment inside will not cause a refrigerant charge leakage. The maximum number of pieces of equipment permitted to be stored together is determined by local regulations.
6. The appliance must be stored in a manner that prevents mechanical damage from occurring.
7. All maintenance personnel and others working in the local area shall be instructed on the nature of work being carried out. Work in confined spaces should be avoided. The area around the workspace should be sectioned off. Ensure that conditions within the area have been made safe by control of flammable material.

GETTING STARTED

For better heating and cooling efficiency, follow the steps outlined below.

- 1) Extend the exhaust hose within a length of less than 400 mm. The exhaust hose must be kept unblocked.
- 2) Keep a minimum distance of 500mm from the appliance's filter side to the wall or any other obstacles.
- 3) If the appliance starts to defrost, the word "DF" will appear on the LED display.

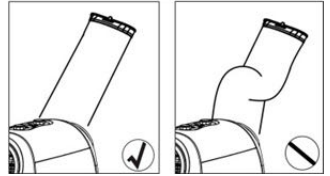

THANK YOU FOR PURCHASING OUR HIGH-PERFORMANCE PORTABLE AIR CONDITIONER

CONGRATULATIONS

This air conditioner is designed and manufactured with the highest of standards and techniques.

An additional remote control is provided to allow you to use the appliance in a convenient manner. This appliance's features are outlined below.

- **High-Mobility: Moves easily from room to room with easy glide castors.**
- **Plug-and-Start: Plug and start the appliance after simple exhaust hose and window kit installations. (follow the figures in p10)**
- **Strong Cooling: Powerful refrigerating system cools down the ambient temperature instantly.**
- **Clean Air Cycle: Dehumidified and filtered air effectively improves air quality.**
- **Easy Controls: One touch electronic pad provides easy-to-identify icon for users operation.**
- **Compact Timer: 24-hour programmable timer for cooling, heating, and dehumidifying modes.**
- **User-Friendly Sleep Mode**
- **Applicable power source: 220~240V/50Hz**

UNPACK THE APPLIANCE

1. Place the appliance in an upright position.
2. Cut the two packing straps.
3. Lift the outer carton slightly to release the appliance from the base.
4. Grip the handles on either of the appliance sides and carefully release it from the foam base.
5. Remove the hot air outlet to take out exhaust hose and (upper/ lower) hose adapters.

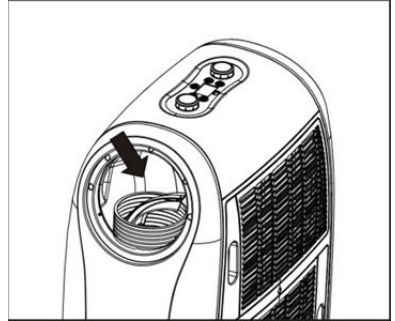

CONTENTS

1. Portable air conditioner appliance (1 pc)
2. Remote control (1 pc)
3. A-type window kit (2 pcs)
4. Upper/Lower hose adapters (1 pc each)
5. Connection tube (1 pc)
6. Exhaust hose (1 pc)
7. Batteries (2 pcs)

NAME OF PARTS

1. Control panel
2. Remote control receiver
3. Adjustment dials
4. Adjustable air vent
5. Connection tube
6. Exhaust hose
7. Upwards drain hole

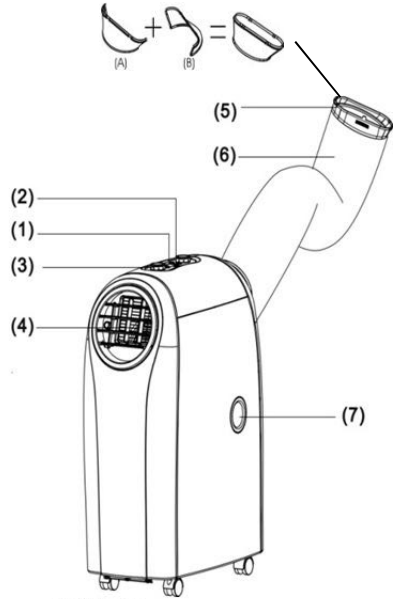

8. Cool air inlet
9. Cool air filter
10. Hot air inlet
11. Hot air filter
12. Downwards drain hole

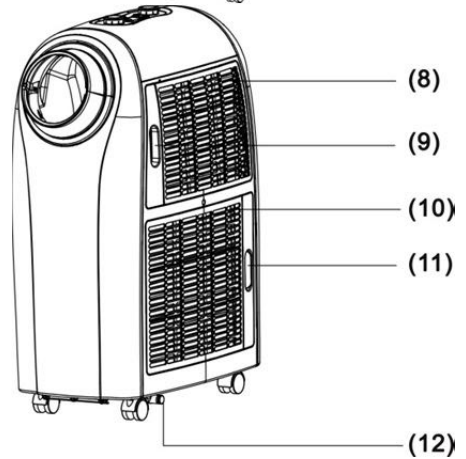

HOT AIR OUTLET INSTALLATION

Follow steps below to assemble the appliance hose adapters before use.

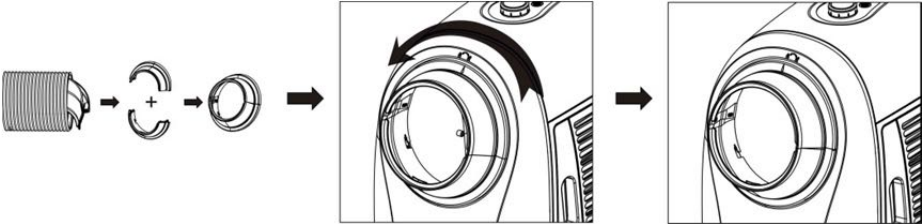

EXHAUST HOSE INSTALLATION

1. Follow directions of figure ① to rotate the exhaust hose, then remove the hose from the appliance.
2. Follow the directions of figure ② to rotate the exhaust hose, then fix the hose firmly to the appliance.

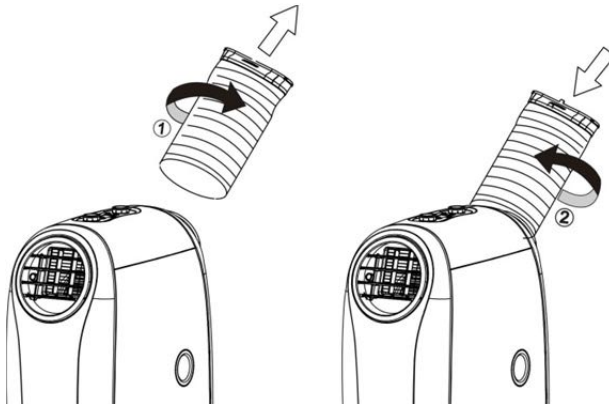

WINDOW KIT INSTALLATION

Follow the steps below to install the window kits vertically or horizontally. Slide the window kit to adjust the length fitting into the window.



Window slider kit

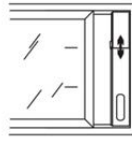

Window slider kit



HEATING MODE PREPARATIONS

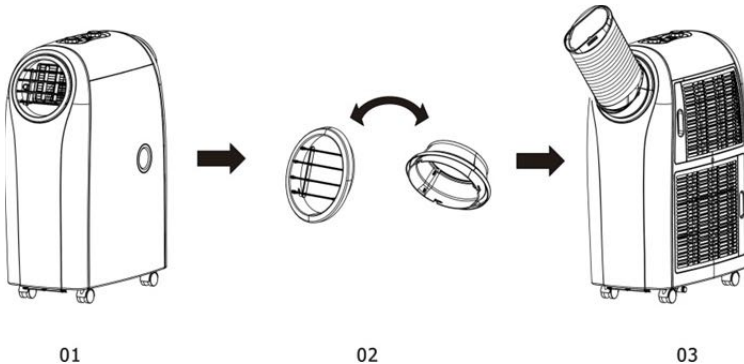

- ◆ To use the heating function, follow the steps below.
Remove and reverse the hot and cold air outlet, then reinstall the air outlets in accordance with figure 03. Finally, turn on the appliance and switch to "Heating" mode.

Important: Allow air to flow freely out of the unit.

In the cooling and heating modes it is possible to set the unit outside the cooled or heated room. In this configuration in a cooled/heated room the noise level of the unit will be much lower however the efficiency of the unit will be much higher.

The necessary conditions for such use are:

1. In cooling mode, the outdoor temperature must be below 35°C.
The place where the air conditioner is placed should be shady and well ventilated.
2. In heating operation, the outdoor temperature must be higher than 7°C.
The unit should be protected from rain, sunshine and dust.

Exhaust hose connection method:

The air conditioner always blows cold air through the front outlet. Depending on whether you want to cool or heat the room, connect the exhaust hose accordingly.

Air conditioner inside the room:

Cooling mode

- Exhaust hose connected to the back of the unit to exhaust hot air to the outside through the window kit

Heating mode

- Exhaust hose connected at the front of the unit to exhaust cold air to the outside through the window kit

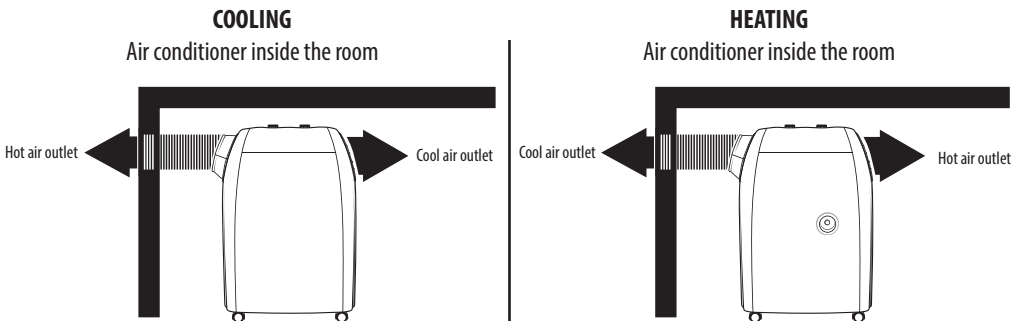

When using the unit outside the room, depending on whether you want to cool or heat the room, the exhaust hose must be connected accordingly:

Cooling mode

- Exhaust hose connected at the front of the unit and led to the inside of the room through the window kit

Heating mode

- Exhaust hose is connected to the rear of the unit and routed inside the room through the window kit

COOLING

Air conditioner outside the room

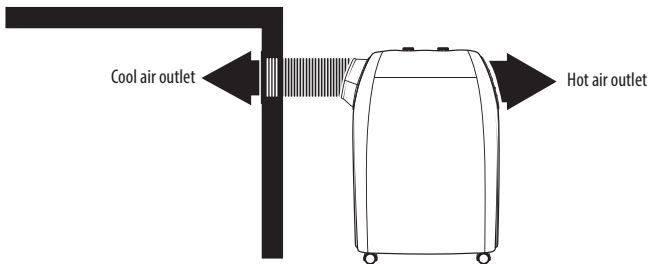

HEATING

Air conditioner outside the room

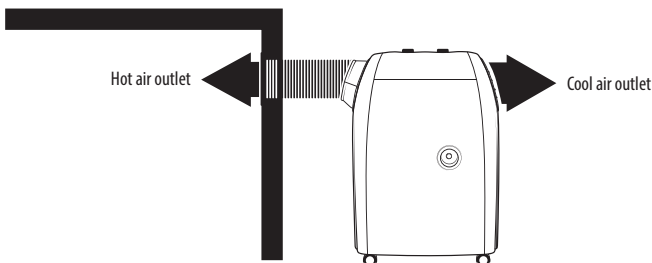

CONTROL PANEL & OUTLINE OF FUNCTIONS

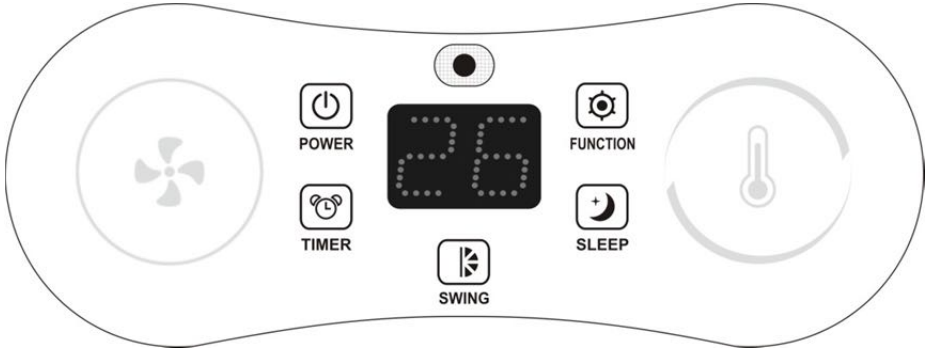

: LED DISPLAY

: POWER

: MODE



: TIMER

: SLEEP

: SWING





I. KEY FUNCTION DESCRIPTIONS:

- (1) **POWER** (On/Off Key) :
 - a. Standby mode (Default)
 - b. Turn appliance on/off





- ◆ Turn on the appliance and the <  > indicator will light on.
- ◆ Turn off the appliance to move standby mode and the <  > indicator will light off.

(2) **MODE** (Switch Function Key)  : switches between Cooling (Default) → Dehumidifying → Heating → Cooling.



a. COOLING:

- ◆ The <  > indicator will light on.
- ◆ The <  > indicator will turn blue.
- ◆ If the compressor shuts down, the <  > indicator will blink.
- ◆ The <  > display will show the temperature on the screen.

b. DEHUMIDIFYING

- ◆ The <  > indicator will light on.
- ◆ The <  > indicator will turn green.
- ◆ If the compressor shuts down, the <  > indicator will blink.
- ◆ The <  > display will show "dH" on the screen.





c. HEATING:

- ◆ The <  > indicator will light on.
- ◆ The <  > indicator will turn red.
- ◆ If the compressor shuts down, the < **HEAT** > indicator will blink.

- ◆ The <> display will show the temperature on the screen.

(3) **TEMP.** (Temperature and Humidity Dial) :





a. COOLING/HEATING:

- ◆ Rotate the < > dial clockwise. The value increases by 1°C/1°F per scale. The maximum value is 30°C/86°F (25°C/77°F).
- ◆ Rotate the < > dial counter-clockwise. The value decreases by 1°C/1°F per scale. The minimum value is 17°C/63°F (15°C/59°F).
- ◆ While rotating the < > dial, the < > display will continuously flash. After adjustment, the < > display will show the configured temperature.



b. DEHUMIDIFYING:

- ◆ In DEHUMIDIFYING mode, the < > dial is disabled.











c. TIMER:

- ◆ Rotate the < > dial clockwise direction to increase the value by +1h per scale.
- ◆ Rotate the < > dial counter-clockwise to decrease the value by -1h per scale.
- ◆ Press the < > key before rotating the < > dial. The < > display will flash the on/off time during configuration. The final configuration will be displayed once set.

(4) **SPEED** (Fan Speed Dial) :



- a. Rotate the  dial counter-clockwise direction to change the speed from Auto<AU>→High<F3>→Mid.<F2>→Low<F1>.
- b. Rotate the  dial counter-clockwise direction to change the speed from Auto<AU>→High<F3>→Mid.<F2>→Low<F1>.
- c. In COOLING mode, fan speeds can be adjusted from Low, Mid, and High to Auto. The  display will show <F1>, <F2>, <F3> and <AU> on the screen.
- d. The default fan speed is medium<F2>.

(5) **TIMER** (Auto-On/Auto-Off)  :

- a. Press the  key to activate the timer. The  indicator will light on. Press the  key again to cancel the setting. The  indicator will light off.
- b. While the appliance is in use, press the  key and rotate the  dial to configure Auto-Off from 0-24 hours.
- c. While the appliance is on standby, press the  key and rotate the  dial to configure Auto-On from 0-24 hours.
- d. To configure the TIMER, rotate the  dial clockwise/counter-clockwise to adjust the value by +1h/-1h per scale.
- e. During TIMER, press and hold the  key for 1 second to increase the time continuously.

(6) **SLEEP** (SLEEP Mode Key)  :



- a. SLEEP function in COOLING mode:

- ◆ The  indicator will light on.
 - ◆ The temperature increases by 1 °C/2 °F after an hour and 2 °C/4 °F after 2 hours. After which, the temperature will remain unchanged.
- b. SLEEP function in HEATING mode:
- ◆ The  indicator will light on.
 - ◆ The temperature decreases by 1 °C/2 °F after an hour and decreases by 2 °C/ 4 °F after 2 hours. After which, the temperature will remain unchanged.
- c. The SLEEP function is disabled in DEHUMIDIFYING mode.

(7) **SWING** (Vent Auto-Swing) :









- a. The  indicator will light on/off when Auto-Swing is enabled/disabled.
- b. The appliance defaults to enabled Auto-Swing when powered on.
- c. Auto-Swing can be configured through either the appliance or the remote control.
- d. The air vent defaults back to the center when the appliance is turned off.
- e. Auto-Swing is disabled if the appliance is in neither HEATING nor DEHUMIDIFYING mode.

II. STANDBY Mode:

In standby mode, only the  indicator and  light will turn on in low brightness.

III. TIMER Mode:

- (1) TIMER scale: from 0-24 hours.

- (2) Use the TIMER to configure the Auto-Off time during operation, or configure the Auto-On time in standby mode.
- (3) While configuring the TIMER, both the  key and the  dial are available to adjust the desired time.
- (4) With each press of the TIMER key, the value on the  display increases from "00" → "01" → to "24" and back to "00" again.
- (5) Configure the Auto-Off timer:
 - a. Press the  key to preset the Auto-Off timer. The  display will flash the configured time on the screen. After configuration, the display will return to show the operating mode after 5 seconds.
 - b. Press the  key before the preset time to cancel the Auto-Off timer. The appliance will turn off.
- (6) Set the Auto-On timer:
 - a. While configuring the Auto-On timer, you can preset functions at the same time.
 - b. Press the  key to configure the Auto-On timer. After configuration, the display will show the remaining time.
 - c. Press the  key before the preset time to cancel the Auto-On timer. The appliance will turn on.
 - d. After configuring the Auto-On timer, the appliance will remain available to control or switch to other functions.

IV. SLEEP Mode:

- (1) The appliance defaults not to SLEEP mode disabled when powered on.

(2) SLEEP function in COOLING mode:

- ◆ The  indicator will light on.
- ◆ The temperature increases by 1°C/2°F after an hour and 2°C/4°F after 2 hours. After which, the temperature will remain unchanged.

(3) SLEEP function in HEATING mode:

- ◆ The  indicator will light on.
- ◆ The temperature decreases by 1°C/2°F after an hour and decreases by 2°C/4°F after 2 hours. After which, the temperature will remain unchanged.

(4) The SLEEP function is disabled in DEHUMIDIFYING mode.

V. Temperature Display Switching (°C/°F):

(1) The temperature display defaults to Fahrenheit (°F).

(2) In standby mode, press and hold the  key for 5 seconds to switch the temperature display between Celsius (°C) and Fahrenheit (°F). The display flashes <88> once on screen and produces one short beep to indicate the temperature has switched.

VI. Protection





(1) Compressor Protection

The compressor stays off for 3 minutes or above before restarting.

(2) Defrost Protection

(a) The  display will show <dF> on the screen.

(b) The appliance defrosts when the internal temperature is too low until the normal temperature is restored. The display will return to showing the functions.

- (3) The <> display will show <E1> if the indoor T-round thermistor malfunctions. All indicators will turn off and the appliance shuts down. After the problem is resolved, the appliance will resume to its previous operation.
- (4) The <> display shows <E2> if the indoor T-coil thermistor malfunctions. All indicators will turn off and the appliance shuts down. After the problem is resolved, the appliance will resume to its previous operation.
- (5) Water Full Protection
- (a) The <> display will show <E4> on the screen.
- (b) The appliance will stop working when the water is full and <E4> will show on the screen. After the problem is resolved, the appliance will return to standby. Press the <> key to restart.

REMOTE CONTROL FUNCTION

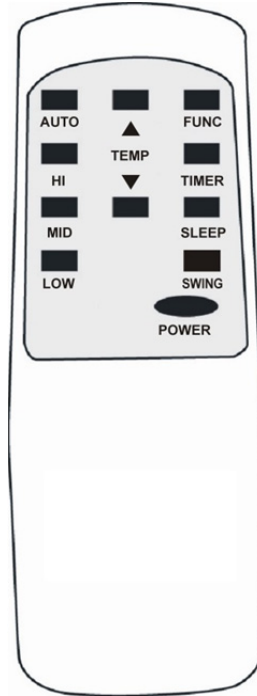

1. POWER
2. FUNC
3. TIMER
4. AUTO
5. HI
6. MID
7. LOW
8. SLEEP
9. TEMP.
10. SWING

On/Off switch
"MODE" selector
Hour configuration
Automatic fan speed
High fan speed
Medium fan speed
Low fan speed
Night operation selector
Temperature selector
Swing

IMPORTANT MESSAGES

The appliance evaporates and distributes condensation through the exhaust hose.

1. In COOLING mode, the drain pipe does not need to be installed. Ensure the rubber cap locked on the drain hole when the appliance is in operation.
2. In HEATING mode, pull out the rubber cap ① to install the drain pipe to ensure heating efficiency.
3. In DEHUMIDIFYING mode, pull out the rubber cap ① to install the drain pipe, then remove the exhaust hose to ensure dehumidifying efficiency.

※ When the water tank is full, the  display will show <E4> on screen. Remove the rubber cap ② of the bottom drain hole to release the water. After draining, press the power button to restart the appliance.

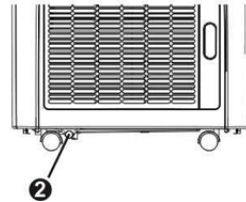
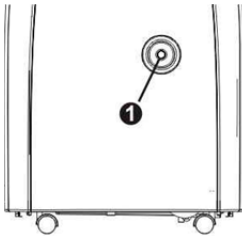

MAINTENANCE

DISCONNECT THE POWER CORD BEFORE CLEANING.

Air Filters

Air filters are located at the left hand side of the appliance. Simply remove the filters by pulling the frame out through the direction indicated by the arrow.

Condenser/Evaporator

Use a vacuum cleaner with a brush.

Plastic Case

Wipe with a damp cloth and polish with a soft cloth.

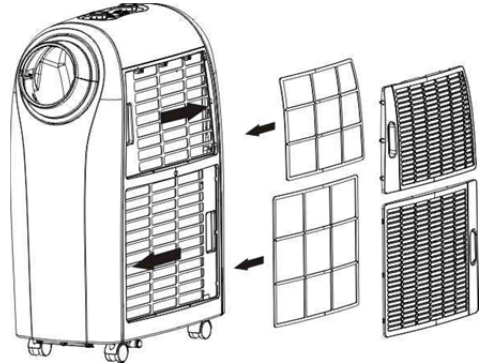

POWER SUPPLY

1. Ensure that the cable is connected to the correct power source.
2. Insert the plug into the outlet firmly to prevent electric leaks.
3. Never pull the power cable forcefully to prevent damage.



USE LOCATION

1. Place the appliance in a wide and ventilated location to ensure a smooth exhaustion.
2. Never place the appliance in a humid or wet location to avoid electric leak hazards.
3. Do not place the appliance in a sunlit corner to ensure the appliance does not overheat and shut down. The color of the appliance may also change or fade.

NOTES

The appliance is fitted with a special thermal cutoff device.

Ensure that the appliance is not placed against any objects (e.g. furniture or curtains).
Obstructing air inlets may affect performance dramatically.

Troubleshooting

1. Servicing Information

- 1) Checks the area

Prior to starting work on systems containing flammable refrigerants, safety checks are necessary to ensure that the risk of ignition is minimised. The following precautions must be complied prior to repairing the refrigerating system.

- 2) Procedure

Work shall take place under a controlled procedure to minimise the risk of a flammable gas or vapour being present while the work is being performed.

- 3) Check for the refrigerant

The area shall be checked with an appropriate refrigerant detector prior to and during work to ensure the technician is aware of potentially flammable

atmospheres. Ensure that the leak detection equipment used is suitable for flammable refrigerants, i.e. non-sparking, adequately sealed, or intrinsically safe.

4) Fire extinguisher

If any high temperature work needs to be conducted on the refrigeration equipment or any associated parts, appropriate fire extinguishing equipment must be available to hand. Have a dry powder or CO₂ fire extinguisher adjacent to the area.

5) No ignition sources

No person carrying out work in relation to a refrigeration system which involves exposing any pipe work that contains or has contained flammable refrigerant should use any sources of ignition in such a manner that may lead to the risk of fire or explosion. All possible ignition sources, including cigarette smoke, should be kept sufficiently far away from the site of installation, repair, removal, and disposal, during which flammable refrigerant may be released to the surrounding area. Prior to work taking place, the area around the equipment is to be surveyed to ensure that there are no flammable hazards or ignition risks. "No Smoking" signs shall be displayed in the area.

6) Area ventilation

Ensure that the area is in the open or adequately ventilated before breaking into the system or conducting any high temperature work. An adequate level of ventilation must be maintained for the period that the work is carried out. Ventilation should safely disperse any released refrigerant and preferably expel it externally into the atmosphere.

7) Check refrigeration equipment

If electrical components need to be swapped, they must be fit for the purpose and match provided specifications. Manufacturer maintenance and service guidelines must be followed at all times. If in doubt, consult the manufacturer's technical department for assistance.

Check the below before installation using flammable refrigerants.

- The charge size must be in accordance with the size of the room in which the refrigerant containing parts are installed.
- Ventilation machinery and outlets can operate adequately and are not obstructed.
- If an indirect refrigerating circuit being used, the secondary circuit must be checked for refrigerant.
- Equipment marking remains visible and legible. Markings and signs that are illegible must be corrected.
- The refrigeration pipe and other components must be installed in a position where they are unlikely to be exposed to any substance which may corrode refrigerant container components, unless the components are constructed of materials which are inherently resistant to or sufficiently protected against corrosion.

8) Check electrical devices

Repair and maintenance of electrical components must be carried out after initial safety checks and component inspection procedures. If a fault exists that could compromise safety, immediately disconnect the electrical supply until the fault is resolved. If the fault cannot be immediately resolved but it is necessary to continue operation, an adequate temporary solution must be applied. This solution must be reported to the owner of the equipment to ensure all parties are notified.

Initial safety checks shall include the below.

- Capacitors must be discharged in a safe manner to avoid the possibility of sparking.
- No live electrical components and wiring must be exposed while charging, recovering, or purging the system.
- There must be ground continuity.

2. Repairs to sealed components

- 1) During repairs to sealed components, all electrical supply must be disconnected from the equipment being worked on prior to any removal of sealed covers, etc. If it necessary to have an electrical supply to equipment during servicing, then a permanent form of leak detection shall be located at the most critical point to warn of a potentially hazardous situation.
- 2) Particular attention shall be paid to ensure that during work on electrical components, casing is not altered in such a way that the level of protection is affected. This shall include damage to cables, excessive connections, terminals not designed to original specification, damage to seals, incorrect fitting of glands, and others.

Ensure that appliance is mounted securely.

Ensure that seals or sealing materials have not degraded to the extent that they no longer serve the purpose of preventing the ingress of flammable atmospheres. Replacement parts must be serviced in accordance with manufactures specifications.

NOTE: The use of silicon sealants may inhibit the effectiveness of some types of leak detection equipment. Intrinsically safe components do not have to be isolated prior to servicing.

3. Repair to intrinsically safe components

Do not apply any permanent inductive loads or load capacitance to the circuit without ensuring that this will not exceed the permissible voltage and current for the appliance in use.

Intrinsically safe components are the only types that can be serviced while live in the presence of a flammable atmosphere. The test apparatus must be of the correct rating. Replace components only with parts specified by the manufacturer. Use of other components may result in the ignition of refrigerant in the atmosphere from a leak.

4. Cabling

Check that cabling is not subject to wear, corrosion, excessive pressure, vibration, sharp edges, or any other adverse environmental effects. This check should take into account the effects of wear or continual vibration from sources such as compressors or fans.

5. Detection of flammable refrigerants

Under no circumstances should potential sources of ignition be used in the search for or detection of refrigerant leaks. A halide torch (or any other detector utilizing a naked flame) should not be used.

6. Leak detection methods

The following leak detection methods are deemed acceptable for systems containing flammable refrigerants.

Electronic leak detectors should be used to detect flammable refrigerants but may require re-calibration as sensitivity may not be adequate (detection equipment should be calibrated in a refrigerant-free area). Ensure that the detector is not a potential source of ignition and is suitable for the refrigerant used. Leak detection equipment should be set at a percentage of the LFL of the refrigerant and calibrated to the appropriate gas percentage (25% maximum) confirmed.

Leak detection fluids are suitable for use with most refrigerants. The use of detergents containing chlorine shall be avoided as the chlorine may react with the refrigerant and corrode copper pipework.

If a leak is suspected, all naked flames should be removed or extinguished.

If a refrigerant leak that requires brazing is found, all refrigerant must be recovered from the system or isolated with shut-off valves in a part of the system remote from the leak. Oxygen-free nitrogen (OFN) must then be purged throughout the system both before and during the brazing process.

7. Removal and evacuation

Conventional procedures must be used when breaking into the refrigerant circuit to make repairs or for any other purpose. Best practices must be followed since flammability is a consideration. The procedures below must be followed.

- Remove the refrigerant.
- Purge the circuit with inert gas.
- Evacuate the system.
- Purge again with inert gas.
- Open the circuit by cutting or brazing.

Recover the refrigerant charge into the correct recovery cylinders. Flush the system with OFN to ensure appliance safety. This process may need to be repeated several times. Compressed air or oxygen should not be used for this task. Flushing shall be achieved by breaking the vacuum in the system with OFN and continuing to fill until the working pressure is achieved, venting to the atmosphere, then pull down to a vacuum. This process must be repeated until no refrigerant is within the system. When the final OFN charge is used, the system should be vented down to atmospheric pressure to allow for servicing. This step is absolutely vital if brazing operations on the pipework are required. Ensure that the vacuum pump outlet is not close to any ignition sources and there is adequate ventilation available.

8. Charging procedures

In addition to conventional charging procedures, the below requirements must not be followed.

- Ensure that contamination of different refrigerants does not occur when using charging equipment. Hoses or lines must be as short as possible to minimise the amount of refrigerant contained within.
- Cylinders must be kept upright.

-
- Ensure that the refrigeration system is earthed prior to charging the system with refrigerant.
 - Label (if not already) the system when charging is complete.
 - Take extreme care not to overfill the refrigeration system. Pressure test the system with OFN prior to any recharge. The system should be leak tested on completion of charging and prior to commissioning. A follow up leak test should be carried out prior to transportation away from the site.

9. Decommissioning

Before carrying out this procedure, the technician must be completely familiar with the equipment and all its details. It is recommended good practice that all refrigerants are recovered safely. Prior to decommissioning, an oil and refrigerant sample should be taken in case analysis is required prior to reuse of the reclaimed refrigerant. It is essential that electrical power is available before decommissioning begins.

- a) Personnel should be familiar with the equipment and its operation.
- b) Isolate the system electrically.
- c) Before attempting the procedure, ensure the below.
 - Mechanical equipment is available, if required, for the handling of refrigerant cylinders.
 - All personal protective equipment is available and is utilized correctly.
 - The recovery process is supervised at all times by a competent person.
 - Recovery equipment and cylinders conform to the appropriate standards.
- d) Pump down refrigerant system, if possible.
- e) If a vacuum is not possible, create a manifold so that refrigerant can be removed from various parts of the system.

-
- f) Ensure that the cylinder is situated on the scales before recovery is carried out.
 - g) Start and use the recovery machine in accordance with manufacturer instructions.
 - h) Do not overfill the cylinders to any more than 80% of volume liquid charge.
 - i) Do not in any circumstances exceed the maximum working pressure of the cylinder.
 - j) When the cylinders have been filled correctly and the process is completed, ensure that the cylinders and equipment are removed from site promptly and all isolation valves on the equipment are closed off.
 - k) Recovered refrigerant must not be charged into another refrigeration system unless cleaned and checked.

10. Labelling

Equipment should be labelled to state that it has been decommissioned and emptied of refrigerant. The label must be dated and signed. Ensure that there are labels on the equipment stating it contains flammable refrigerant.

11. Recovery

When removing refrigerant from a system for servicing or decommissioning, it is recommended good practice that the refrigerants are completely removed in a safe manner.

When transferring refrigerant into cylinders, ensure that only appropriate refrigerant recovery cylinders are employed. Ensure that the correct number of cylinders is available to hold total system charge. All cylinders marked for use should be designated and labelled for the recovered refrigerant. Cylinders should be complete with pressure relief valves and associated shutoff valves in good working order. Empty recovery cylinders should be evacuated and cooled if possible before recovery occurs.

Recovery equipment should be in good working order, include clear instructions at hand, and shall be suitable for the recovery of flammable refrigerants. Additionally, a set of calibrated weighing scales should be available and in good working order. Hoses should be complete with leak-free disconnect couplings and in good condition. Before using the recovery machine, check that it is in satisfactory working order, has been properly maintained, and that any associated electrical components are sealed to prevent ignition in the event of refrigerant release. Consult the manufacturer if in doubt.

The recovered refrigerant should be returned to the refrigerant supplier in the correct recovery cylinder with the relevant Waste Transfer Note arranged. Do not mix refrigerants in recovery units and especially not in cylinders.

If compressors or compressor oils are to be removed, ensure that they have been evacuated to an acceptable level so no flammable refrigerant remains within the lubricant. The evacuation process should be carried out prior to returning the compressor to the supplier. Only electric heating to the compressor body may be employed to accelerate this process. When oil is drained from a system, it shall be carried out safely.

Fuse parameters

Type: 5ET or SMT

Voltage: 250V

Current: 3.15 A

TROUBLESHOOTING

Code	Cause of Problem	Solution
E1	Electrical short on rubber temperature sensor and PCB	Contact the service center.
E2	Electrical short on copper temperature sensor and PCB	Contact the service center.
E4	Water plate is full	Pull out the rubber stopper located at the bottom of the appliance to drain the water out.

SPECIFICATION

Model No.	BAC-PO-1414-Q11L
Power Source	220-240V-50Hz
Rated Power (EN60335)	
Cooling	1535W
Heating	1290W
Cooling Capacity	4000W
Heating Capacity	4000W
Moisture Removed	70 Liters/day
IP Class	IP24
Refrigerant	R290, 0.27kg
Permissible Excessive Operating Pressure	
Suction:	0.6MPa
Discharge:	2.5MPa
Maximum Allowable Pressure	4.0MPa
Dimensions (mm)	330Wx550Dx790H



This marking indicates that this product should not be disposed with other household waste throughout the EU. To prevent possible hazards to the environment or human health from uncontrolled waste disposal, please recycle the product in a safe manner for the sustainable reuse of material resources. Please ask return and collection systems or contact the retailer from where the product was purchased to return your used device, as they can recycle the products safely.

MODEL CODE BREAKDOWN

BAC-PO-1414-Q11L

B	AC	PO	14	14	Q	11	L
---	----	----	----	----	---	----	---

B – Blaupunkt

AC – Air conditioner

PO – Portable

14 – 14000 BTU heating capacity

14 – 14000 BTU cooling capacity

Q – Balcony unit

11 – Internal number

L - IP24/water splash protection